

User's Manual

VAB705X Series

Fiber Optic Baseband Video /Stereo Audio

Installation and User Guide

Revision 2.0 FEB 2006

VAB705X Series Users and Installation Manual

Radiant Communications makes every effort to ensure that this document is accurate. However, because we are always improving our products, we are unable to guarantee the accuracy of the contents of this document after the date of publication and we disclaim liability for any changes, error or omissions.

Copyright

Copyright © 2004 by Radiant Communications. Printed in the United States of America. No part of this publication may be reproduced, stored in a retrieval system, or transmitted, in any form or by any means, electronic, mechanical, photocopying, recording, or otherwise, without written permission of the publisher.

All rights reserved, VAB705X Series User's Manual

Limitation of Liability

In no event shall Radiant Communications be liable for any defect in hardware or software or loss or inadequacy of data of any kind, or for any direct, indirect, incidental, or consequential damages in connection with or arising out of the performance or use of any product furnished hereunder. Radiant Communication's responsibility shall in no event exceed the purchase price of the product purchase hereunder. The foregoing limitation of liability shall be equally applicable to any service provide by Radiant Communications or its authorized agent.

TABLE OF CONTENTS

1 SAFETY INSTRUCTIONS

2 INTRODUCTION

- 2.1 System Configuration
 - 2.1.1 Video/Audio Transmitter
 - 2.1.2 Video/Audio Receiver Front View
 - 2.1.3 Video/Audio Receiver Rear View
- 2.2 Equipment Description
 - 2.2.1 Base Model Descriptions
- 2.3 Example Applications

3 INSTALLATION

- 3.1 Unpacking The Unit
- 3.2 General Installation
- 3.3 Power Connection
 - 3.3.1 Receiver
 - 3.3.2 Transmitter
- 3.4 Fiber Optic Cables Connection
- 3.5 Fiber Optic Ports
- 3.6 Video Cables
- 3.7 Audio Connections
 - 3.7.1 Differential (Balanced)
 - 3.7.2 Singled Ended (Unbalanced)

4 OPERATION

- 4.1 Turn On Procedure

TABLE OF CONTENTS

5 MAINTENANCE and TROUBLESHOOTING

- 5.1 Maintenance
- 5.2 Troubleshooting

6 SPECIFICATIONS

- 6.1 Technical specifications

7 CUSTOMER SUPPORT

- 7.1 Return Policy
- 7.2 Advance Replacement Policy
- 7.3 Warranty Policy

1 SAFETY INSTRUCTIONS

THE VAB705X SYSTEM MAY CONTAIN A CLASS IIIb LASER. PLEASE OBSERVE THE FOLLOWING SAFETY PRECAUTIONS THAT APPLY TO LASER EQUIPT UNITS.

WARNING: Do not disconnect the fiber optic external connector with the power turned on. Exposure to Class IIIb Laser radiation is possible when the external fiber connector is disconnected while the unit is still powered up. Ensure the rubber boot is in place whenever the fiber optic cable is disconnected.

CAUTION: Attempting to make adjustments or performing operations other than those specified may result in hazardous radiation exposure. Exposure for only seconds can cause permanent eye damage as well as other injuries.

2 INTRODUCTION

This manual is a guide to the installation, operation, applications and maintenance of the VAB705X series fiber optic video optic transmission system.

2.1 System Configuration Overview

2.1.1 Video / Stereo Audio Transmitter Front

The VAB705XT and the VAB705XR share the same indicator panel. The indicators provide information regarding the local optical link, the optical link at the remote end (relative to observer) and presence of video and data activity. The front and rear panels are shown below:

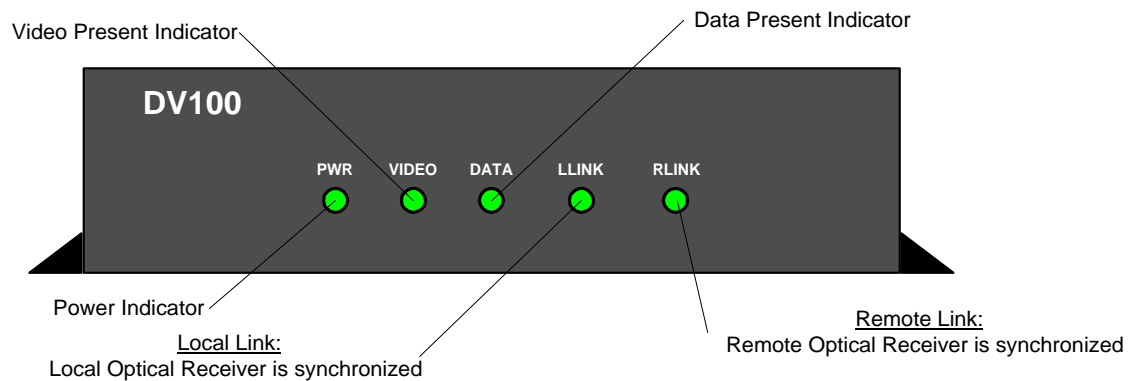

VAB705X FRONT VIEW

Optical Transmission Link Indicators:

The presence of Local Link (LLINK) on the front panel indicates that the INCOMING optical digital signal is synchronized and being received without errors. In order for ANY OTHER INDICATORS to be valid, the LLINK LED must be illuminated GREEN.

The Remote Link Indicator (RLINK) indicates that the remote end's (relative to observer) optical digital signal is synchronized at the remote end and is being received without errors. This indicator is not applicable to this particular model because it operates in single direction. This indicator requires bi-directional operation to become functional.

2.1.2 Video / Audio Rear View

The VAB705XT and the VAB705XR also have the same (Modular) rear panel, with the exception of the VAB705XT provides a Video Input BNC and the VAB705XR provides a Video Output BNC. The Modular rear panel is depicted below.

Note: Most newer models provide a 10 pin terminal block.

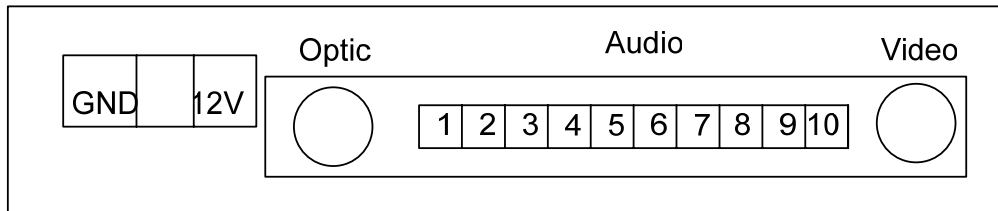

Pin No.	Description
1	Audio 1 +
2	Audio 1 -
3	GND
4	Audio 2 +
5	Audio 2 -
6	N/C
7	N/C
8	N/C
9	N/C
10	GND

VAB705X REAR VIEW

2.2 Equipment Description

The system is capable of transmitting and receiving 1 simplex video signal and 1 duplex audio channel over 1 optical fiber.

Depending on the distance requirements between sites, the VAB705X Series may be equipped to operate over multi-mode fiber or over single mode fiber. Distances between the transmitter and receiver can be up to 10 Km for multi-mode operation and up to 110 Km for singlemode operation.

The VAB705X system employs uncompressed analog to digital modulation techniques, which provides for superior receiver output stability and is unaffected by

changes in the fiber path attenuation caused by environmental factors, splicing or aging.

The VAB705XT accepts the baseband video signal for transmission via an optical digital carrier over a single optical fiber. At the distant end, the VAB705XR receiver accepts the optical carrier and converts it to the output video channels.

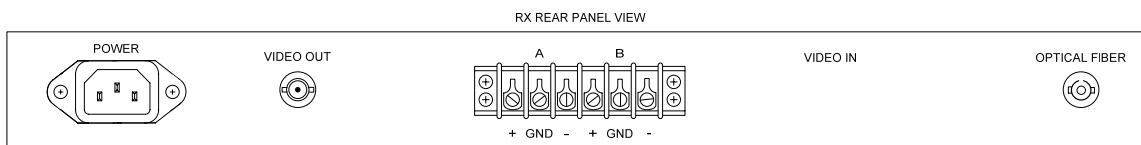
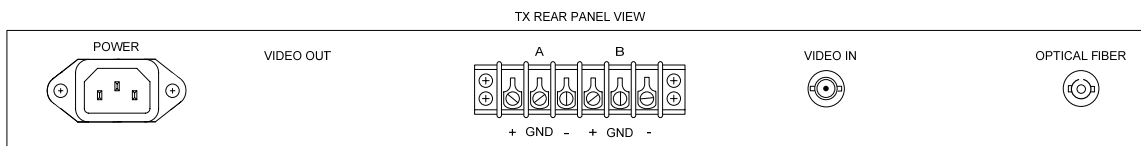
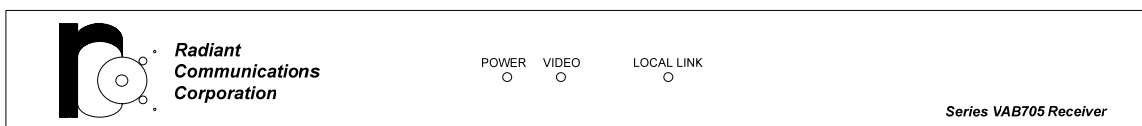
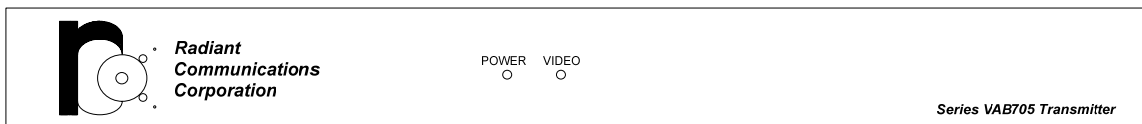

2.2.1 VAB705X SERIES BASE MODELS

The VAB705X Series always includes simplex video. The following table describes the base model Options:

<u>Tx Model</u>	<u>Rx Model</u>	<u>Description</u>
CCTV Versions:		
VA705M-T-XYZ	VA705M-R-XYZ	MM 14DB 850NM
VA705ML-T-XYZ	VA705ML-R-XYZ	MM 12DB 1300NM
VA705S-T-XYZ	VA705S-R-XYZ	SM 14DB 1310NM
Broadcast Versions:		
VAB705M-T-XYZ	VAB705M-R-XYZ	MM 14DB 850NM
VAB705ML-T-XYZ	VAB705ML-R-XYZ	MM 12DB 1300NM
VAB705S-T-XYZ	VAB705S-R-XYZ	SM 18DB 1310 OR 1550
VAB705SL-T-XYZ	VAB705SL-R-XYZ	SM 28SB 1310 OR 1550
Model Notes:		
VAB705X	Video uses 8 Bit CODEC	
VAB705X	Video uses 10 Bit CODEC (Broadcast Quality)	
X	M -MODULAR R -RACK MOUNT U -1U CHASSIS	
Y	D - ST, B -FC, E -SC/UPC A -SC/APC S -FCNAPC	
Z	Wavelength (Varies by Model) 1 -850 2 -1300 3 -1310 5 -1550	

3 INSTALLATION

3.1 Unpacking The Unit

Remove all materials from the packing box and confirm receipt of the following:

- VAB705X-T transmitter (Standalone, Rack mount, 1U)
- VAB705X-R Optical Receiver (Standalone, Rack mount, 1U)
- A/C power cord/Power Cube.
- User's manual.

In the unlikely event that anything is missing, contact your sales representative or call Radiant Tech Support. If it becomes necessary to return the unit(s), repackage the unit in its original box.

3.2 General Installation

Make sure that there is enough space to pull and connect the BNC video source, BNC output cables and optical cables without stressing them beyond the manufacturer's limitation (minimums bend radius).

Install the VAB705X stand alone units such that the environmental specifications are not exceeded.

NOTE: Install the VAB705X such that ventilation is present as this will minimize the possibility of component failures and increase system reliability.

3.3 Power Connection

3.3.1 Stand Alone (Modular)

DC Power connections are made by connecting the 12-16 volts DC @ 1A to the corresponding terminal block connections on the rear of the VAB705X as shown below:

VAB705X Modular Version

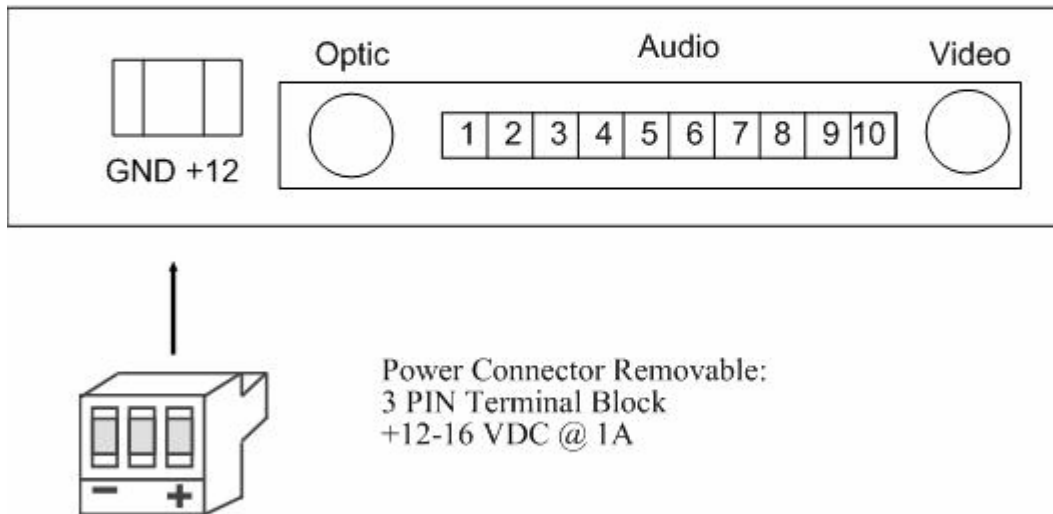

3.3.2 Rackmount Chassis

Slide the VAB705X Rack mount Card into an empty slot. Push firmly to ensure that the card is properly seated into the card slot.

The VAB705X Rack mount Card is hot swappable and may be inserted or removed when power is applied to the chassis.

When power is applied to the chassis, the PWR LED indicator on the VAB705X Rack mount Card will illuminate indicating that the card is powered on.

The chassis power supply is designed for operation over an AC input range of 90 VAC to 240 VAC and input frequency from 47 Hz to 63 Hz and is equipped with a standard IEC three prong power plug which will only fit a grounding type AC outlet.

Note: Do not defeat the purpose of the AC chassis grounding plug or equipment damage may occur

VAB705X Series Installed in 3U 19" EIA Chassis

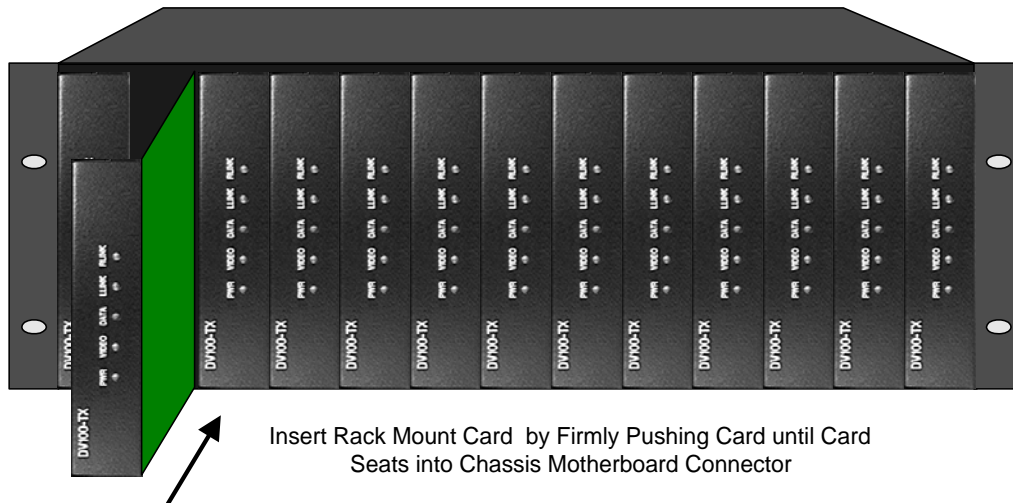

3.3.3 1U 19" CHASSIS

The 1U CHASSIS is designed for operation over an AC input range of 90 VAC to 240 VAC and input frequency from 47 Hz to 63 Hz and is equipped with a standard IEC three prong power plug which will only fit a grounding type AC outlet.

Note: Do not defeat the purpose of the AC chassis grounding plug or equipment damage may occur

3.4 Fiber optic cable connection

The VAB705X Series has the following optical connection options:

- a. ST
- b. FC
- c. SC
- d. SCAPC
- e. FCNAPC

In order to connect the VAB705X Series to the fiber optic cable plant, a compatible fiber optic jumper must be used.

Note: Clean fiber optic jumpers increase transmission distance and reduce reflections.

3.5 Fiber Optic Ports

The following describes the steps required to connect the VAB705X Series Transmitter and Receiver to the fiber optic cable plant.

- a. Proper optical fiber connection between the transmitter and the receiver is to label each individual cable for each channel.
- b. To make connections:
 - . Clean the port: First remove and save the dust caps from the optical port of both the converter and the user device. Wipe the inside of the sleeve with a lint-free pipe cleaner moistened with reagent-grade isopropyl alcohol. Blow dry with dry air.

- Clean the connector: Use lint-free cloth dampened with alcohol to thoroughly wipe the side and end of the ferrule. Blow the ferrule dry with dry air. Visually inspect the ferrule for lint.

To insert connector:

ST-type: Hold the connector by the strain-relief boot and insert the connector ferrule into the port. Rotate the boot until the “key” engages in the slot of the coupling. Push the connector housing forward until it can be turned clockwise to latch to the port.

FC-type: Holding the connector by the strain-relief boot and insert the connector ferrule into the port. Rotate the boot until the “key” engages in the slot of the coupling. Push the connector housing forward and screw turned clockwise until it is tied.

SC Type: Align the SC fiber optic jumper's SC connector such that the SC Key is on top. Align the jumper's ferrule with the VAB705X Fiber Optic port and insert the ferrule. Firmly push the SC jumper's connector all the way into the VAB705X optical SC mating port until the connection clicks into place. Measure the optical output power with an optical power meter to ensure that a low loss connection has been made.

SCAPC Type: See Align the SCAPC fiber optic jumper's SCAPC connector such that the SC Key is on top. Align the jumper's ferrule with the VAB705X Fiber Optic port and insert the ferrule. Firmly push the SCAPC jumper's connector all the way into the VAB705X optical SCAPC (GREEN) mating port until the connection clicks into place. Measure the optical output power with an optical power meter to ensure that a low loss connection has been made. Note: Never mate angle jumpers(Green Boot) with unangled/Flat UPC jumpers(Blue Boot).

FCNAPC Type: Holding the connector by the strain-relief boot and insert the connector ferrule into the port. Rotate the boot until the “key” engages in the slot of the coupling. Push the connector housing forward and screw turned clockwise until it is tied. Note: Never mate angle jumpers(Green Boot) with untangled/Flat UPC jumpers(Blue Boot).

3.6 Video Connections

Video signals are sent over a **75 ohm coax cable terminated in a BNC connector** (e.g. RG 59U with a BNC connector), as follows:

- a. For the VAB705X-T, connect the video source to the VIDEO IN BNC connector.
- b For the VAB705X-R, connect from the VIDEO OUT BNC to the Video Input Equipment

3.7 Audio Connection

The VAB705X Models have a two channels of audio. The VAB705X supports both balanced audio and unbalanced audio. Accessing the audio I/O requires connecting balanced or unbalanced audio. The standard audio is at Line Level. The audio input and output impedances are 600ohms (10k Ohm can be Factory Configured)

<u>Pin No.</u>	<u>Description</u>
1	Audio 1+
2	Audio 1-
3	GND
4	Audio 2+
5	Audio 2-
6	N/C
7	N/C
8	N/C
9	N/C
10	GND

3.7.1 Differential Audio (Balanced)

For Balanced audio connections, wire directly to the 10 terminal block Connector found on both the Modular and Rackmount version of the VAB705X, connect the audio I/O to the respective "+" and "-" leads on the 10 Pin connector, as shown below.

3.7.2 Single Ended Audio (Unbalanced)

For Unbalanced audio connections, wiring directly to the 10 pin Terminal Block on the VAB705X, connect the audio I/O to the respective "+" and "-" leads, attach a jumper from the negative lead to gnd at pin 3.

4 Operation

The VAB705X Series is designed such that once the unit is powered on and the I/O Connectors are attached, no periodic maintenance is required.

Refer to the following installation instructions for operating the VAB705X Series.

1. Mount the VAB705XT and install the power, video and audio connections
2. Measure the Optical Output power and verify that the power is the within specifications for the applicable VAB705X Series Model
3. Attach the fiber optic cable plant to the VAB705XT's optical port
4. Repeat Steps 1 through 3 for the VAB705XR
5. Verify that the LLINK Indicator is illuminated GREEN.
6. Verify that the VIDEO LED Indicator is GREEN (assuming that a valid video source is connected to the VAB705XT)
7. Verify that an acceptable video picture is output from the VAB705XR
8. Verify audio operation using a suitable audio test source and audio receiver

Once the VAB705X System has passed the system check test, the system is available for application objectives.

4.1 Turn-On Procedure

To operate the video transmission system, connect power to the units. The green indicator "POWER" on the front panel shows that the unit is properly powered.

The green LINK light on the receiver should be ON.

This indicates that the receiver is receiving a valid optical signal from the transmitter. There are no adjustments to be made.

5 Maintenance and Troubleshooting

5.1 MAINTENANCE

There is no operator maintenance other than keeping the units clean and verifying that the units are operating in an environment that is within operating specifications for temperature, humidity and power.

5.2 TROUBLESHOOTING

Troubleshooting is the systematic approach to solving a problem. Each step must be performed in sequence, or erroneous test results may be obtained.

The VAB705X Series has one optical transmission indicator: LLINK. RLINK is applicable only in bi-directional systems. Only the VAB705X-R unit has an optical detect status indicator. The LLINK always refers to the Optical Transmission Status of the transmitter.

For example, if you are looking at the front panel of the VAB705XR and the LLINK is illuminated GREEN, this indicates that the VAB705XR is receiving a valid optical signal. If the RLINK LED is GREEN, this means that the remote end unit (e.g. VAB705XT) has a valid optical signal. For troubleshooting purposes LOCAL END refers to the unit with the indicators you are observing and REMOTE END refers to the unit at the other end of the optical cable.

TROUBLESHOOTING GUIDE

The following troubleshooting procedures are based on observing the visual indicators:

TROUBLE	POSSIBLE CAUSE	CORRECTION
POWER LED OFF	<ol style="list-style-type: none"> 1. No Power Input 2. Faulty Unit 	<ol style="list-style-type: none"> 1. Verify the AC Power is present (Rack/1U) Verify Input Power is 12-16VDC for Modular unit. 2. Check / Replace DC PS if faulty 3. Contact Tech Support
LLINK LED OFF	<ol style="list-style-type: none"> 1. No Optical Input 2. Broken Fiber 3. Remote End Off Line 	<ol style="list-style-type: none"> 1. Measure incoming Optical Power 2. Measure REMOTE END Optical Output 3. If no REMOTE END Optical Output Power, Return Unit - Faulty Laser 4. Verify Optical Fiber Integrity (label, break)
LLINK LED ON RLINK LED OFF(Not Applicable)	<ol style="list-style-type: none"> 1. No Laser Output at LOCAL END 2. REMOTE END Rx defective 	<ol style="list-style-type: none"> 1. Measure the LOCAL END's Optical output 2. Try a second unit LOCAL END UNIT 3. Return REMOTE END UNIT
VIDEO LED OFF	<ol style="list-style-type: none"> 1. No Video Source 2. Loose Connection at VAB705XT 3. Defective LED Indicator 	<ol style="list-style-type: none"> 1. Verify that VAB705XT VIDEO is ON 2. Verify that a Video Signal is present 3. If video signal OK, try a second TX unit. 4. Faulty LED, Return Unit
Video Not Working	<ol style="list-style-type: none"> 1. No Video Source 2. Loose Connection at VAB705XT 3. Defective LED Indicator 	<ol style="list-style-type: none"> 1. Verify that VAB705XT VIDEO is ON 2. Verify that a Video Signal is present 3. If video signal OK, try a second TX unit. 4. Faulty LED, Return Unit
Audio Not Working	<ol style="list-style-type: none"> 2. No Audio source, wrong level 3. Bad Audio cable 4. Input or Output Impedance Mismatch 5. Single Ended / Differential Interface Mismatch 	<ol style="list-style-type: none"> 1. Verify Audio Source Present and Levels 2. Verify Audio Cable construction 3. Verify Audio Source and Termination Interfaces 4. Check wiring for either balanced or unbalanced configuration.
LLINK ON RLLINK ON(Not Applicable) No Data (Not applicable)	<ol style="list-style-type: none"> 1. Fault Cable Connections 2. Data Protocol Mismatch 3. RTS / CTS Problem 	<ol style="list-style-type: none"> 1. Verify that the cable is constructed correctly 2. Verify that the RTS / CTS is handled correctly 3. Call for Assistance
Data LED Always ON, Data OK (Not applicable)	<ol style="list-style-type: none"> 1. Faulty Cable Connections 2. Faulty Indicator 	<ol style="list-style-type: none"> 1. Verify Cable Connections. If using RS-232, only connect 3 wires. Connecting RTS/CTS to RS422 I/O will cause DATA LED to be always ON 2. Call for Assistance
Noise in Video during Data Activity (Not applicable)	Data Output is shorted to Ground	<ol style="list-style-type: none"> 1. Verify that the cable is constructed correctly. 2. Verify the terminal equipment data pins
Noise in Video when Audio Connected	Differential Audio Output to Single Ended Audio Receiver puts Noise on VAB705XT or VAB705XR Ground Plane	Verify the Audio Interfaces, levels and impedance's If Single Ended, verify that only the "+" is used and the Singled Ended Ground lead is connected to a VAB705X Audio GND pin

6 Specifications

6.1 Technical specification

Optical

Transmitter:	LASER
Receiver:	PIN/TIA
Wavelength:	850/1300nm Multi-mode 1310nm/1550 Single mode
Power Budget:	14dB MM/850 12dB MM/1300 18dB SM/13/15(STD)
Connectors:	ST, FC, SC, SCAPC, FCNAPC

VIDEO

Signal Level:	1Vp-p nominal
SNR	60 dB (8 Bit), 72 dB (10 Bit)
Diff Gain / Diff Phase	2%, 2 Deg (8 Bit), 1%, 1 Deg (10 Bit)
Impedance:	75 Ohms
Bandwidth, 3dB	10MHZ

AUDIO

Input Impedance	600ohms Min.
Input Signal Level	2 Vp-p Max.
Output Impedance	600 Ohms Max.
Output Signal Level	1:1 Ratio of Input
Bandwidth, 0dB	20 Hz to 15KHz
Dynamic Range	90dB Min.
THD + N	80dB Max.
Connector	10 Pin Terminal Block (Modular/Rackmnt) 3Pin Terminal (1U)

SYSTEM

Indicators:	POWER, LLINK,VID
Power (19" Chassis):	90 to 240VAC/47-63Hz
Power (Modular):	12-16VDC @ 1A

TEMPERATURE

Operating:	0 ⁰ C to 50 ⁰ C
Storage:	-40 ⁰ C to 95 ⁰ C
Humidity:	95% non-condensing

PHYSICAL

Height:	1.3" (Modular/Rack) 1.75" (1U)
Width:	5.5" (Modular/Rack) 16" (1U)
Depth:	7.0" (Modular/Rack) 12" (1U)

Weight: 6.0 oz (Modular/Rack) 1.7LBS(1U)

7 Customer Support

If you ever have any questions, on products or technology, need additional products or documentation, or need to return a unit, please contact your sales representative.

7.1 Return Policy

If you have a problem with the fiber optic mode converter, check all your system connection and configuration. Also, review the troubleshooting section in this manual.

If you can't resolve the problem, contact your dealer/representative or Radiant Communications for customer service.

A Return Material Authorization (RMA) will be required before returning the unit for repair, including warranty repair. To obtain a RMA number, contact Radiant Communication's authorized service representative or distributor. To expedite return, please include the RMA.

7.3 WARRANTY

Electronics

Radiant Communications warrants to the buyer that all goods sold to the buyer will perform in accordance with the applicable data sheets, drawings or written specifications, and at the time of sale will be free of defects in material and workmanship. This warrant shall apply for a period of one year from the date of shipment, unless goods have been subject to lightning damage or other Acts of Nature, misuse, neglect, accident, damage, improper installation or maintenance, or alteration or repair by anyone other than Seller or its Authorized representative. Buyer should notify Radiant Communications promptly in writing of any claim based upon warranty, and Radiant Communications at its option may first inspect such goods at the premises of the Buyer, or may be given written authorization to Buyer to return the goods to Radiant Communications, transportation charges prepaid, for examination by Radiant Communications. Buyer should bear the risk of loss until all goods, authorized to be returned, are delivered to Radiant Communications. Radiant Communications should not be liable for any inspection, packing or labor costs in connection with the return of goods. Radiant Communications' obligations pursuant to this warranty, and sole remedies of the buyers shall be limited to the repair or replacement, or credit of the purchase price, in Radiant Communications' sole discretion.

Optical or Electrical Cables

Carefully inspect the cable upon receipt, if the cable is defective, contact Radiant Communications Customer Service Department within ten (10) days of receipt to obtain a Return Material Authorization (RMA) number before reshipping to Radiant Communications. If defective, the cable will be repaired or replaced in accordance with the warranty of the cable manufacturer, which is the sole warranty. Unless the customer order specifies that Radiant Communications shall install or supervise installation of the cable. Radiant Communications assumes no responsibility for the installation. Radiant Communications should not be liable for defective cable, cost of removing defective cable, or cost of installing replacement cable.